

RTF8080

Features

- SUITABLE FOR BACK PANEL ILLUMINATION, CIRCUIT BOARD INDICATOR, LED INDICATOR.
- BESIDES COLORED DIFFUSED, WATER CLEAR AND TRANSPARENT PACKAGE ARE ALSO AVAILABLE.
- UL RATING : 94V-0.
- HOUSING MATERIAL: TYPE 66 NYLON.

Package Dimensions

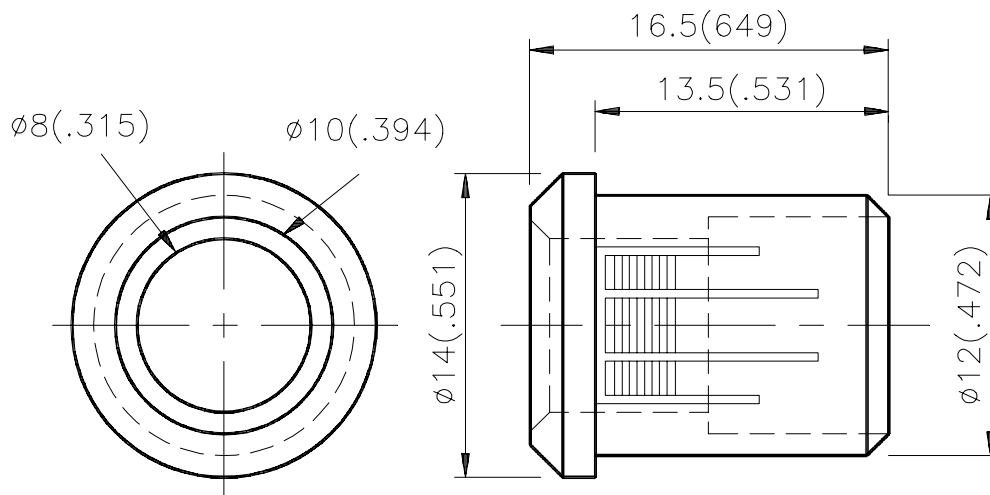

Notes:

1. All dimensions are in millimeters (inches).
2. Tolerance is $\pm 0.25(0.01)$ unless otherwise noted.
3. Lead spacing is measured where the lead emerge package.
4. Specifications are subject to change without notice.